

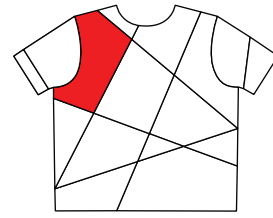

DIY CUT PATTERN

S/M FOR SIZE S/M. SCALE UP TO 2X CURRENT DOCUMENT SIZE

M/L FOR SIZE M/L. SCALE UP TO 2.17X CURRENT DOCUMENT SIZE



FRONT

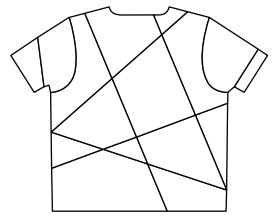

BACK

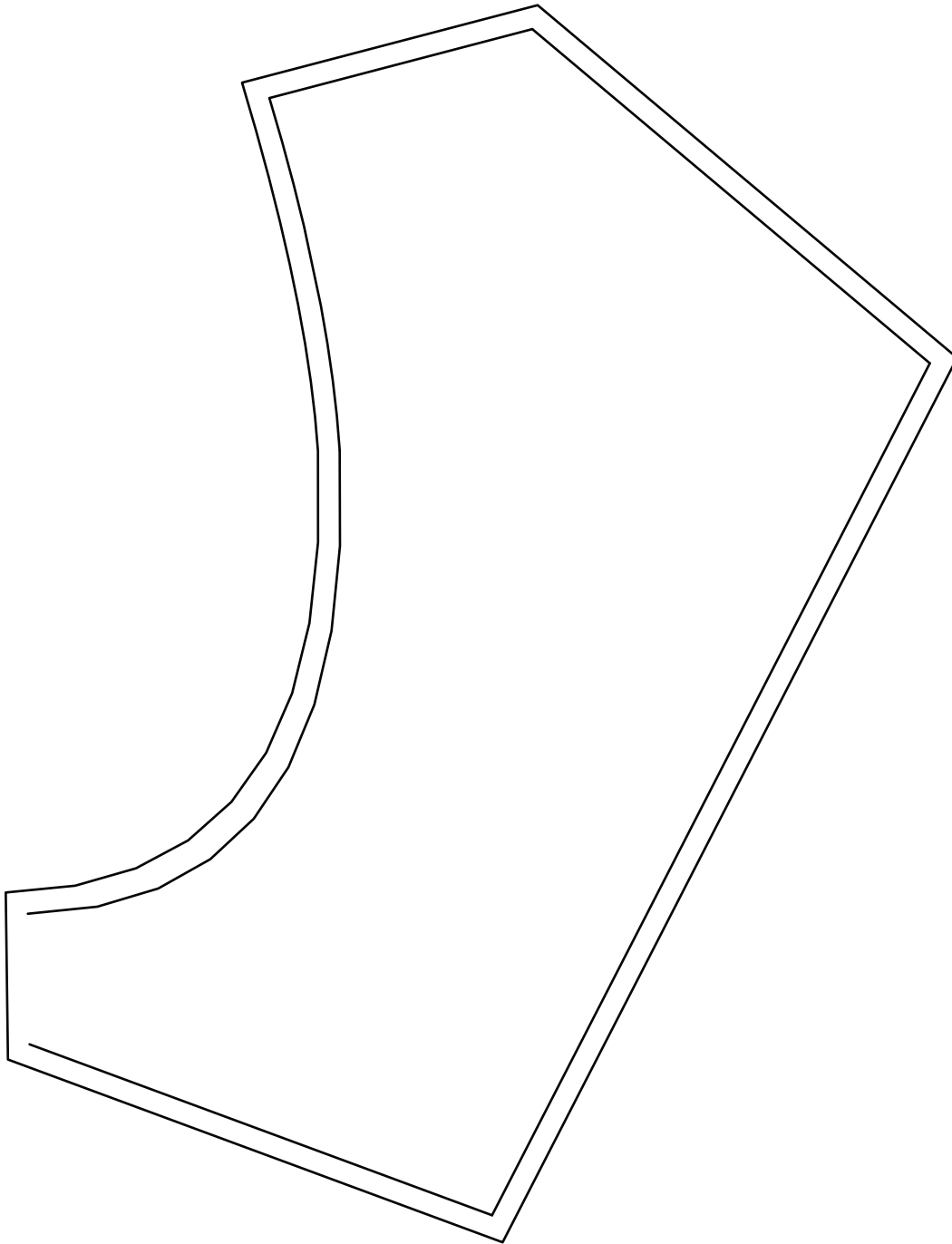



DIY CUT PATTERN

S/M FOR SIZE S/M. SCALE UP TO 2X CURRENT DOCUMENT SIZE

M/L FOR SIZE M/L. SCALE UP TO 2.17X CURRENT DOCUMENT SIZE

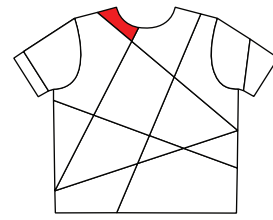

FRONT

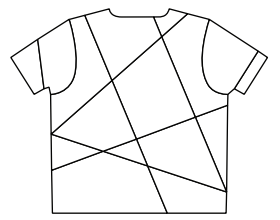

BACK

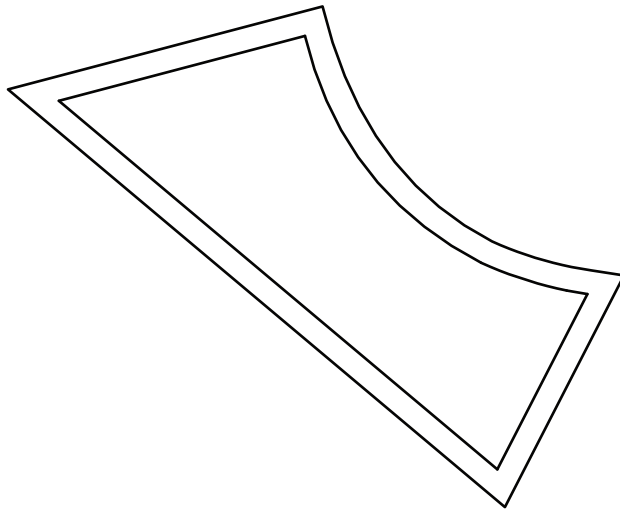



DIY CUT PATTERN

S/M FOR SIZE S/M. SCALE UP TO 2X CURRENT DOCUMENT SIZE

M/L FOR SIZE M/L. SCALE UP TO 2.17X CURRENT DOCUMENT SIZE

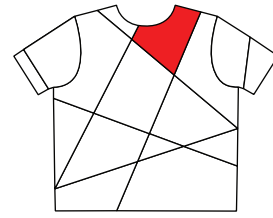

FRONT

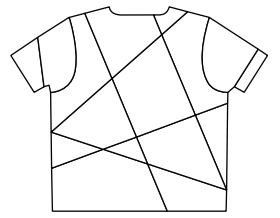

BACK

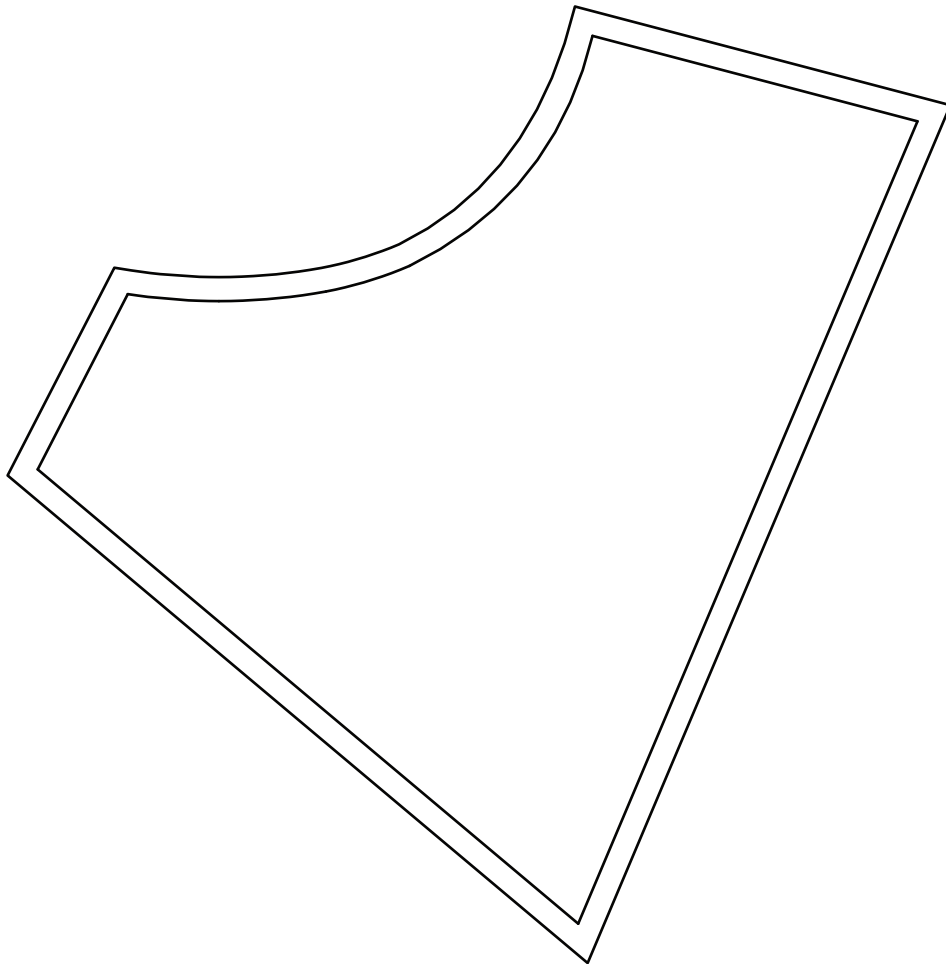



DIY CUT PATTERN

S/M FOR SIZE S/M. SCALE UP TO 2X CURRENT DOCUMENT SIZE

M/L FOR SIZE M/L. SCALE UP TO 2.17X CURRENT DOCUMENT SIZE

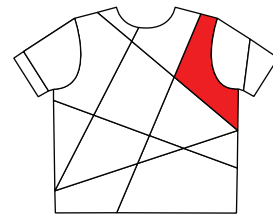

FRONT

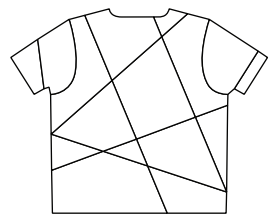

BACK

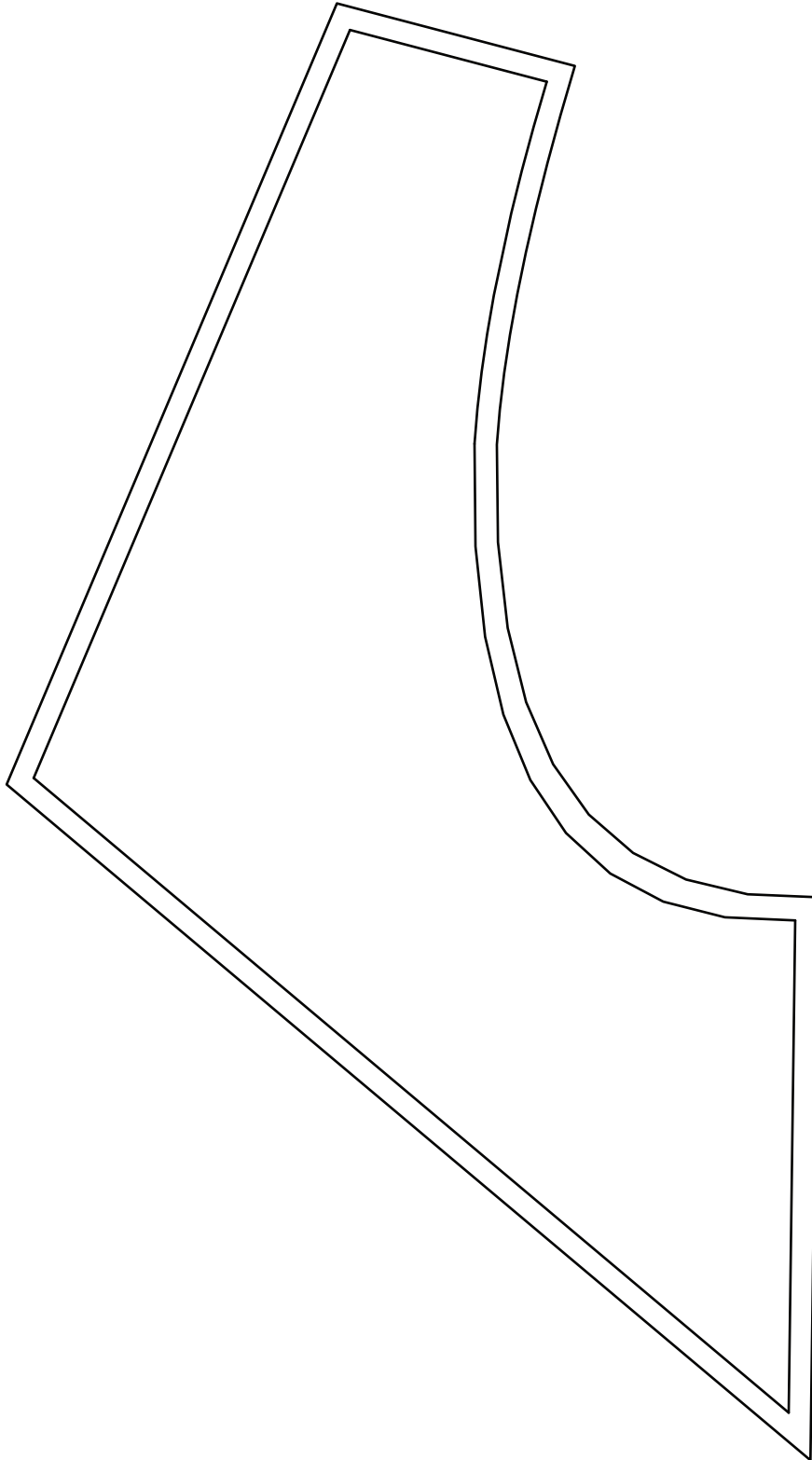



DIY CUT PATTERN

S/M FOR SIZE S/M. SCALE UP TO 2X CURRENT DOCUMENT SIZE

M/L FOR SIZE M/L. SCALE UP TO 2.17X CURRENT DOCUMENT SIZE

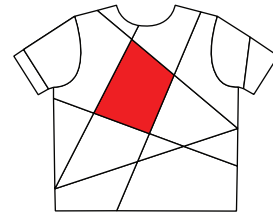

FRONT

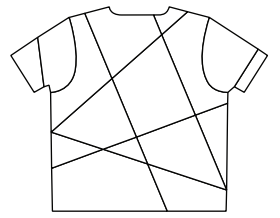

BACK

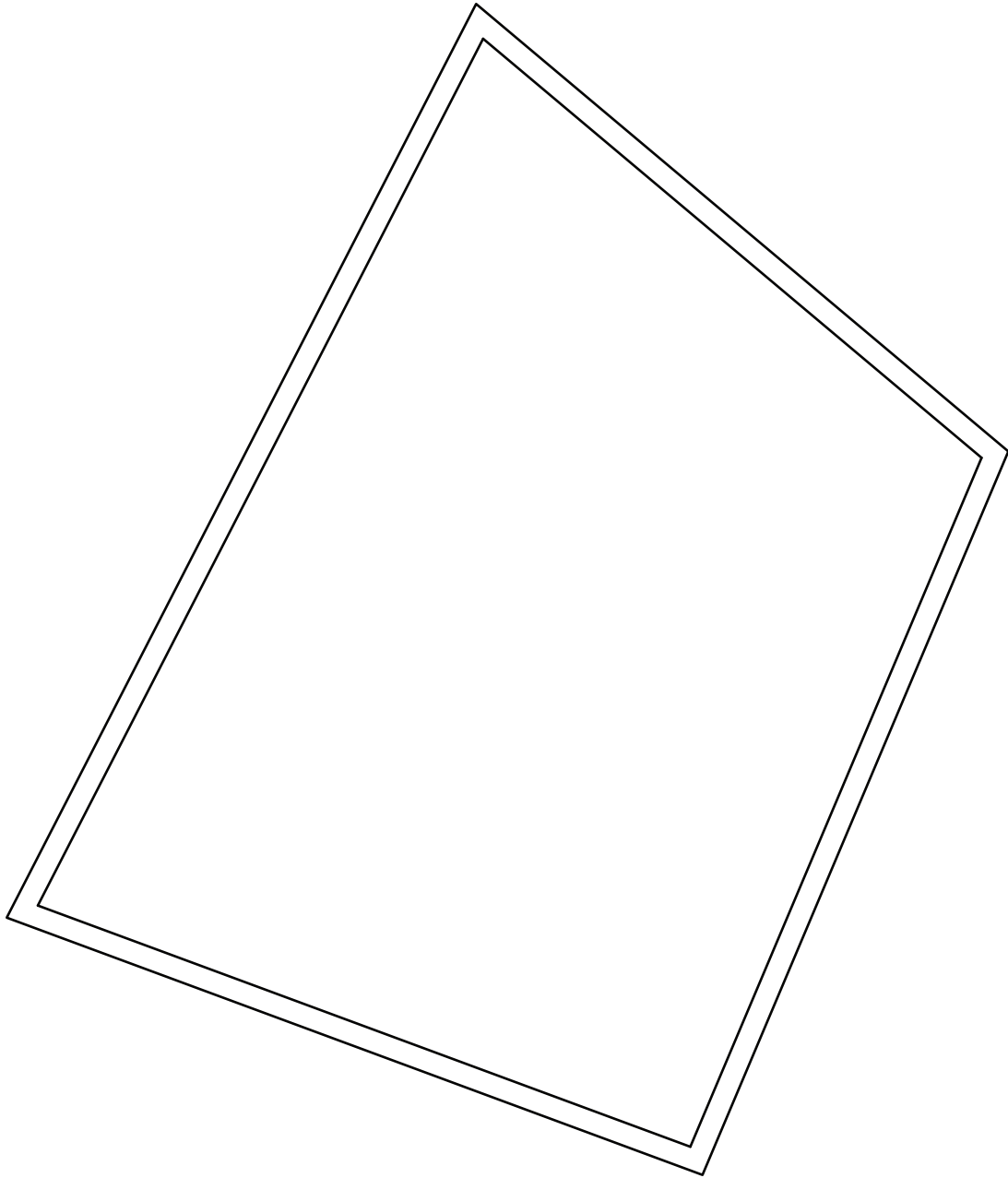



DIY CUT PATTERN

S/M FOR SIZE S/M. SCALE UP TO 2X CURRENT DOCUMENT SIZE

M/L FOR SIZE M/L. SCALE UP TO 2.17X CURRENT DOCUMENT SIZE

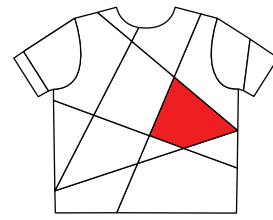

FRONT

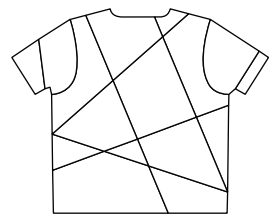

BACK

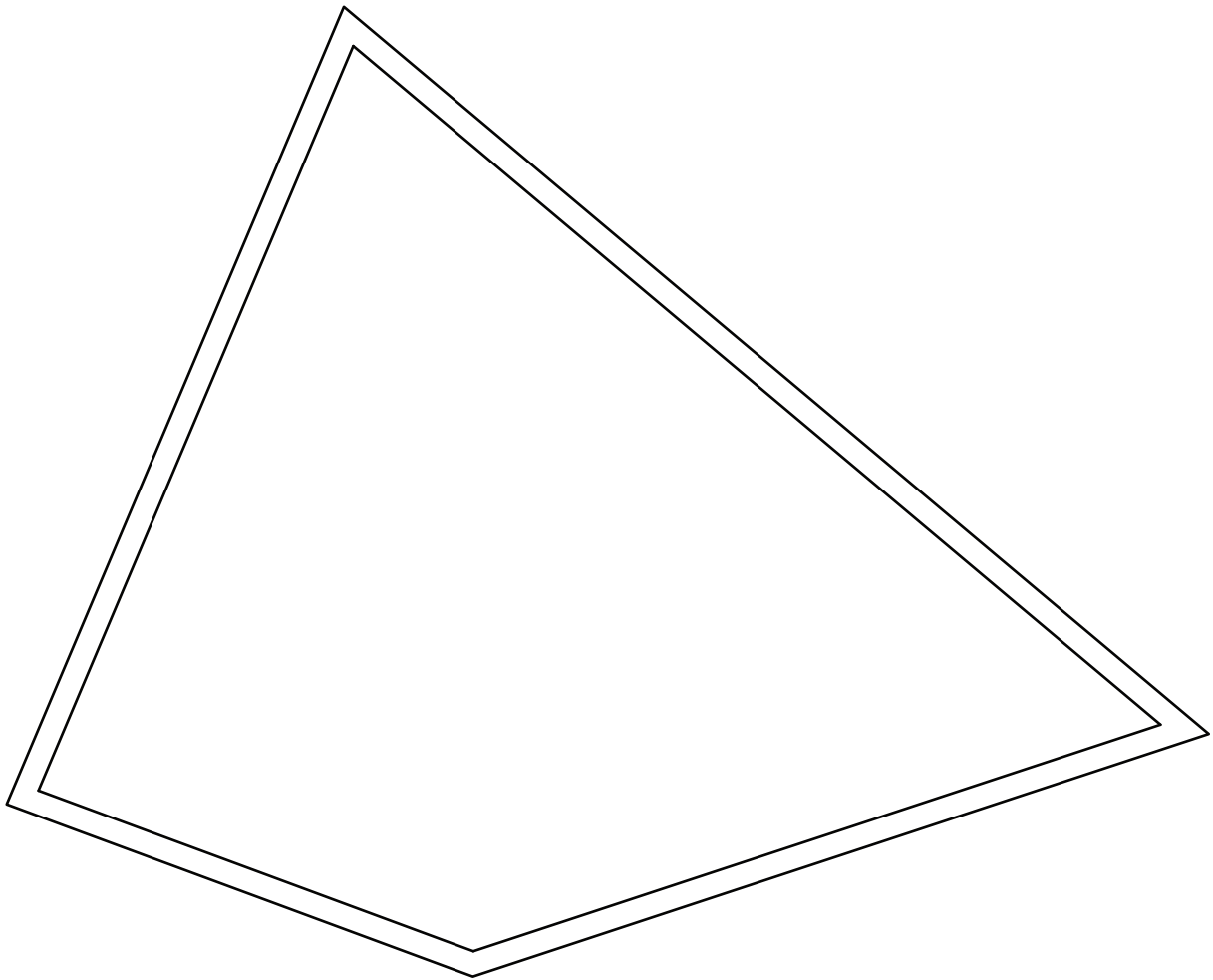



DIY CUT PATTERN

S/M FOR SIZE S/M. SCALE UP TO 2X CURRENT DOCUMENT SIZE

M/L FOR SIZE M/L. SCALE UP TO 2.17X CURRENT DOCUMENT SIZE

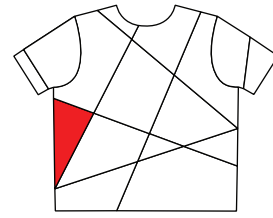

FRONT

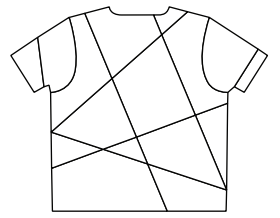

BACK

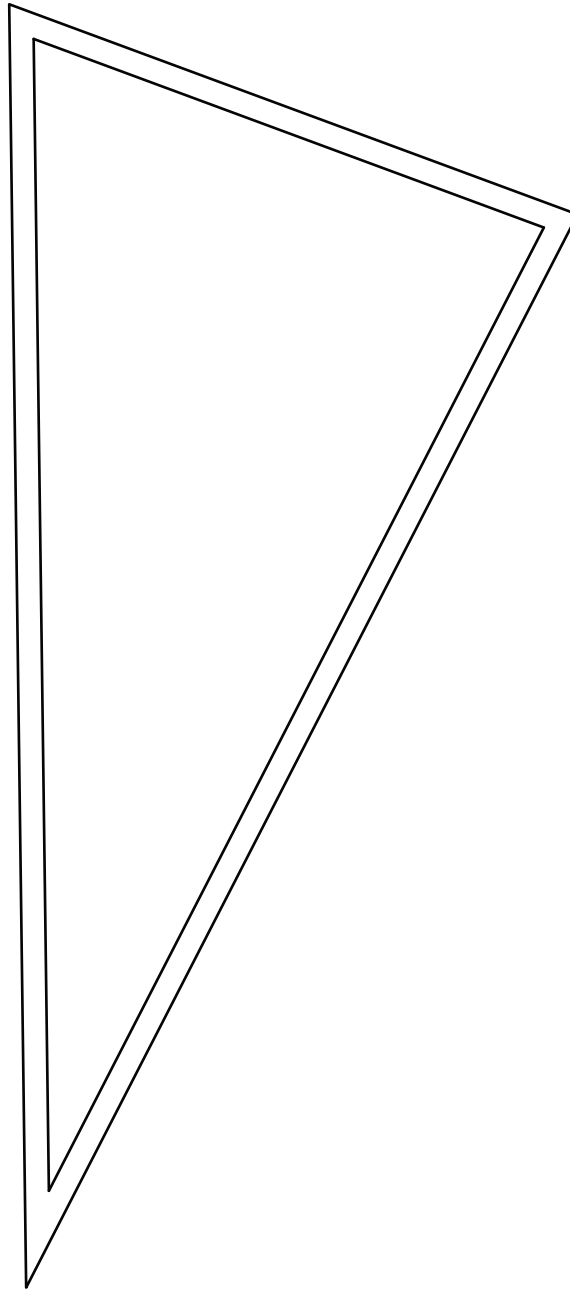



DIY CUT PATTERN

S/M FOR SIZE S/M. SCALE UP TO 2X CURRENT DOCUMENT SIZE

M/L FOR SIZE M/L. SCALE UP TO 2.17X CURRENT DOCUMENT SIZE

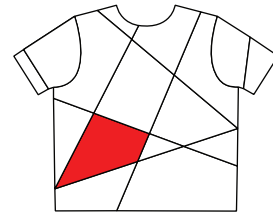

FRONT

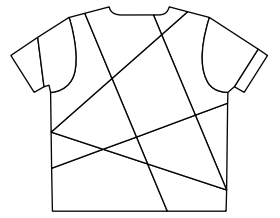

BACK

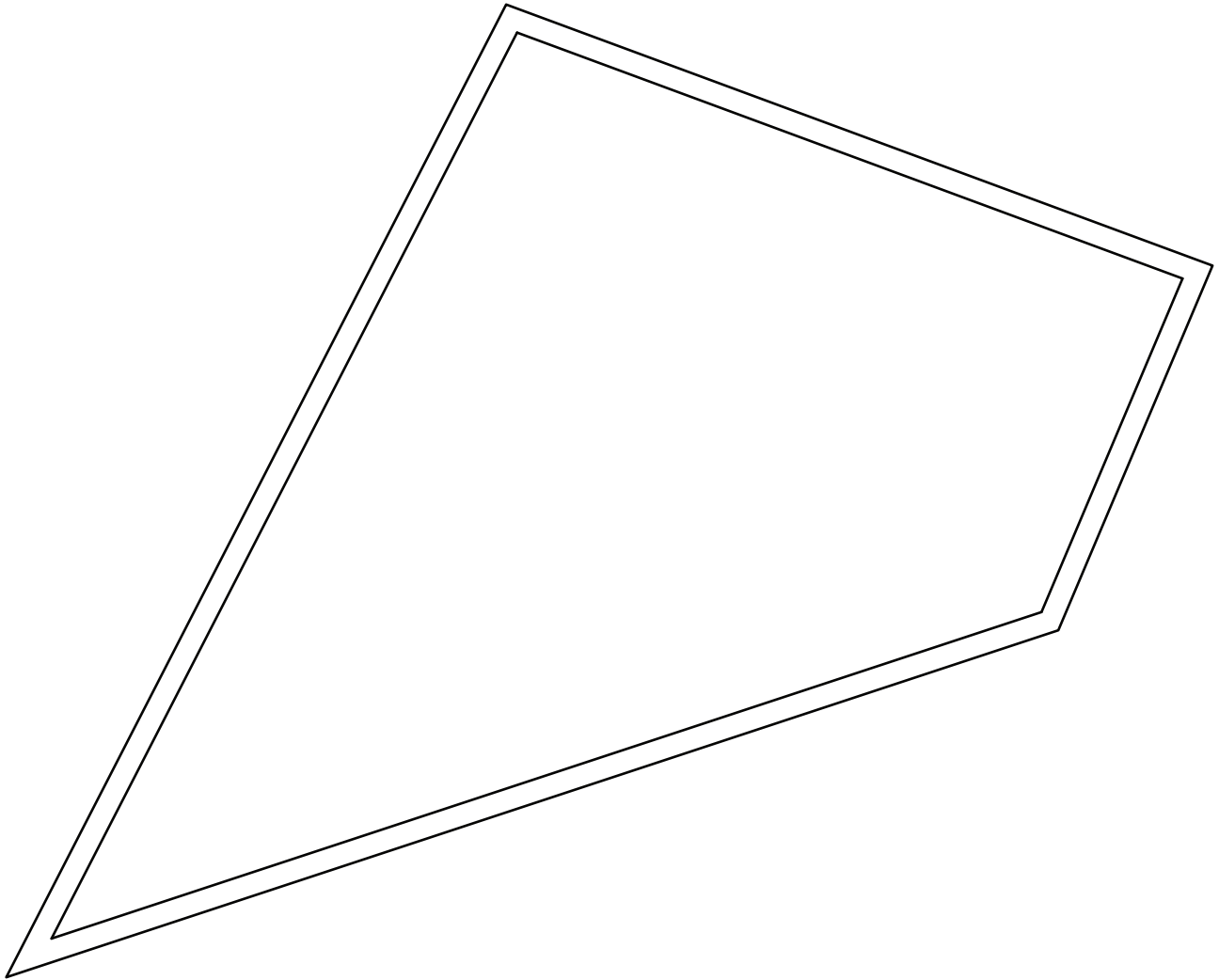



DIY CUT PATTERN

S/M FOR SIZE S/M. SCALE UP TO 2X CURRENT DOCUMENT SIZE

M/L FOR SIZE M/L. SCALE UP TO 2.17X CURRENT DOCUMENT SIZE

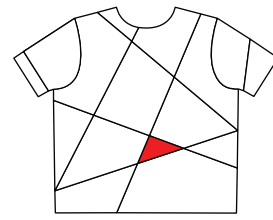

FRONT

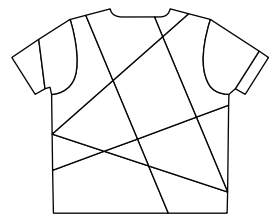

BACK

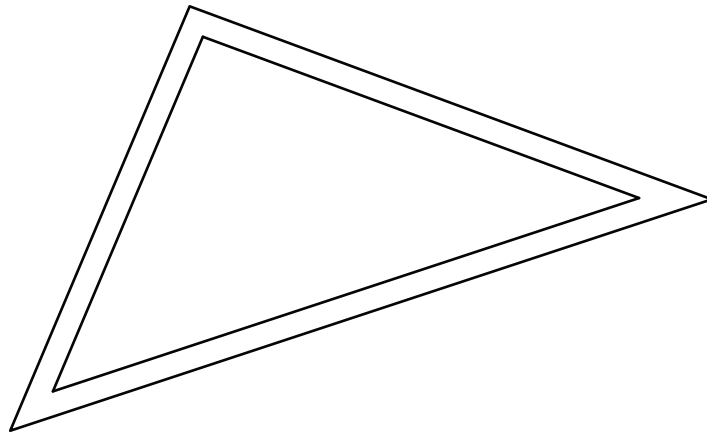



DIY CUT PATTERN

- S/M** FOR SIZE S/M. SCALE UP TO 2X CURRENT DOCUMENT SIZE
- M/L** FOR SIZE M/L. SCALE UP TO 2.17X CURRENT DOCUMENT SIZE

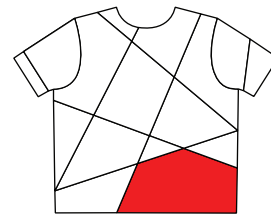

FRONT

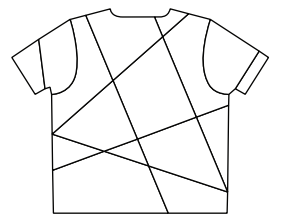

BACK

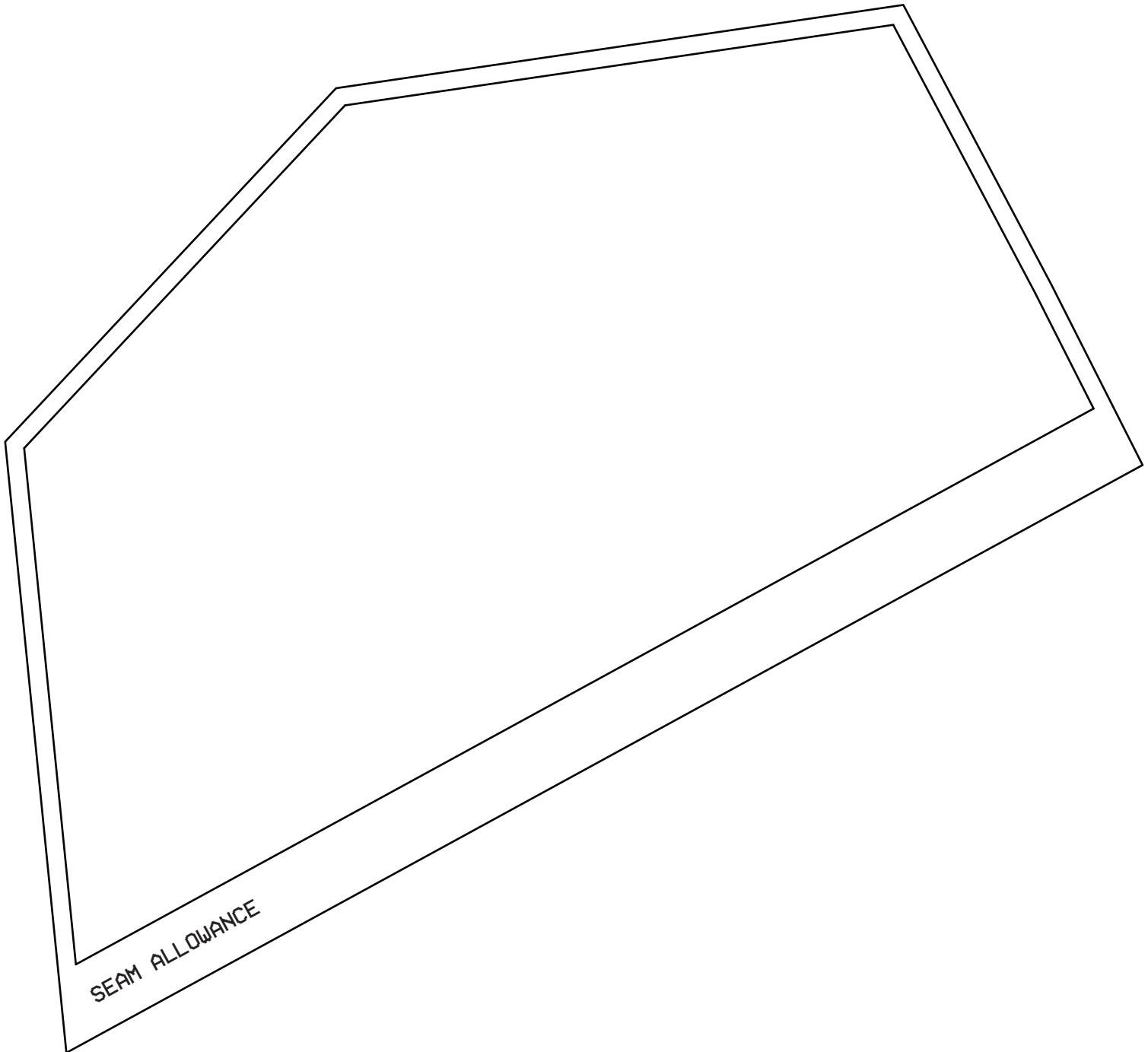



DIY CUT PATTERN

S/M FOR SIZE S/M. SCALE UP TO 2X CURRENT DOCUMENT SIZE

M/L FOR SIZE M/L. SCALE UP TO 2.17X CURRENT DOCUMENT SIZE

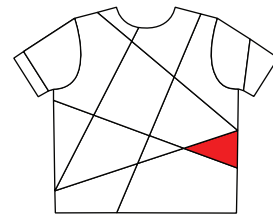

FRONT

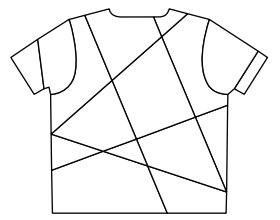

BACK

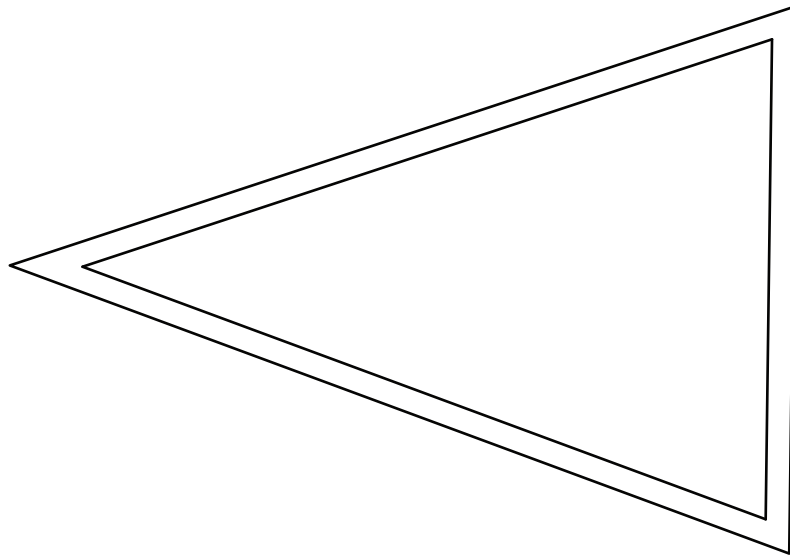



DIY CUT PATTERN

S/M FOR SIZE S/M. SCALE UP TO 2X CURRENT DOCUMENT SIZE

M/L FOR SIZE M/L. SCALE UP TO 2.17X CURRENT DOCUMENT SIZE

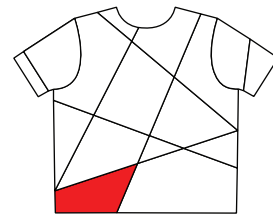

FRONT

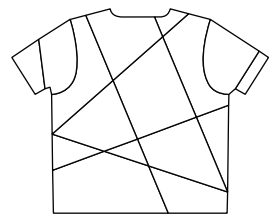

BACK

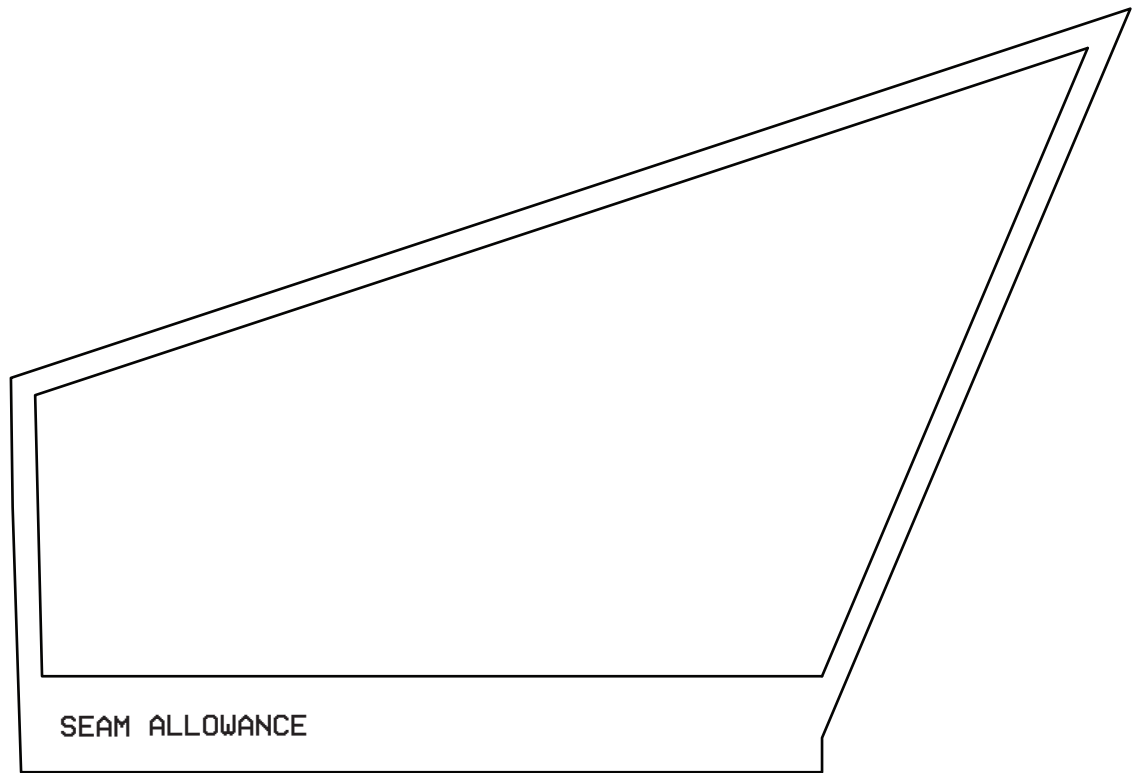



DIY CUT PATTERN

S/M FOR SIZE S/M. SCALE UP TO 2X CURRENT DOCUMENT SIZE

M/L FOR SIZE M/L. SCALE UP TO 2.17X CURRENT DOCUMENT SIZE

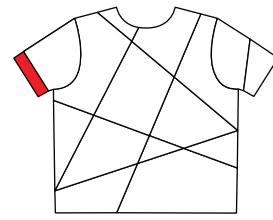

FRONT

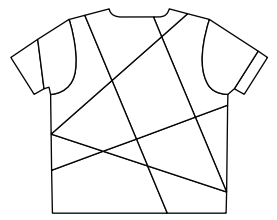

BACK

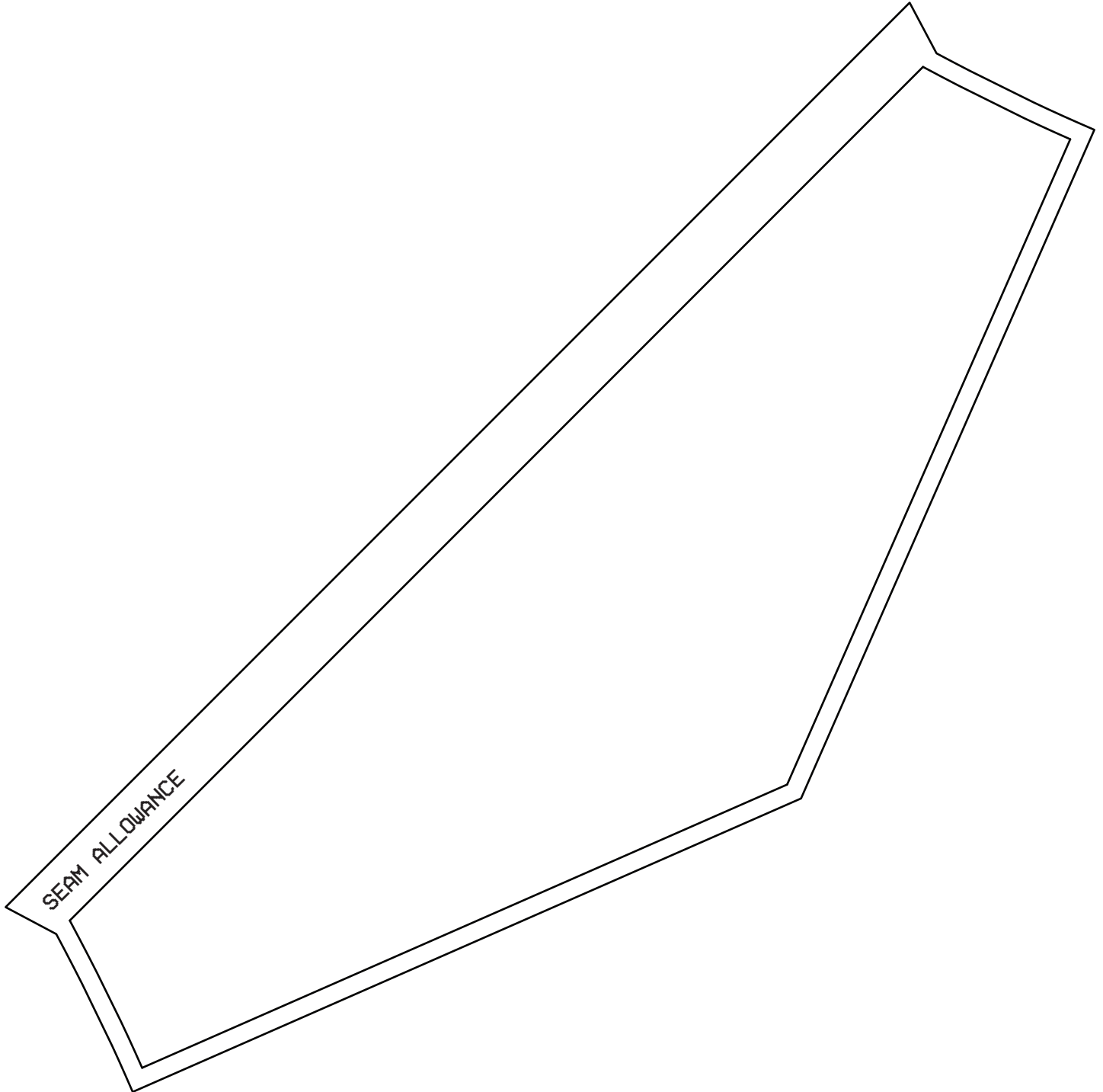



DIY CUT PATTERN

S/M FOR SIZE S/M. SCALE UP TO 2X CURRENT DOCUMENT SIZE

M/L FOR SIZE M/L. SCALE UP TO 2.17X CURRENT DOCUMENT SIZE

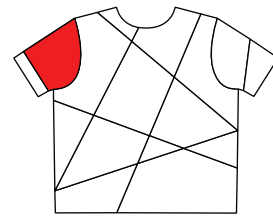

FRONT

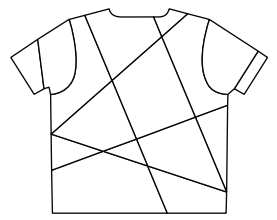

BACK

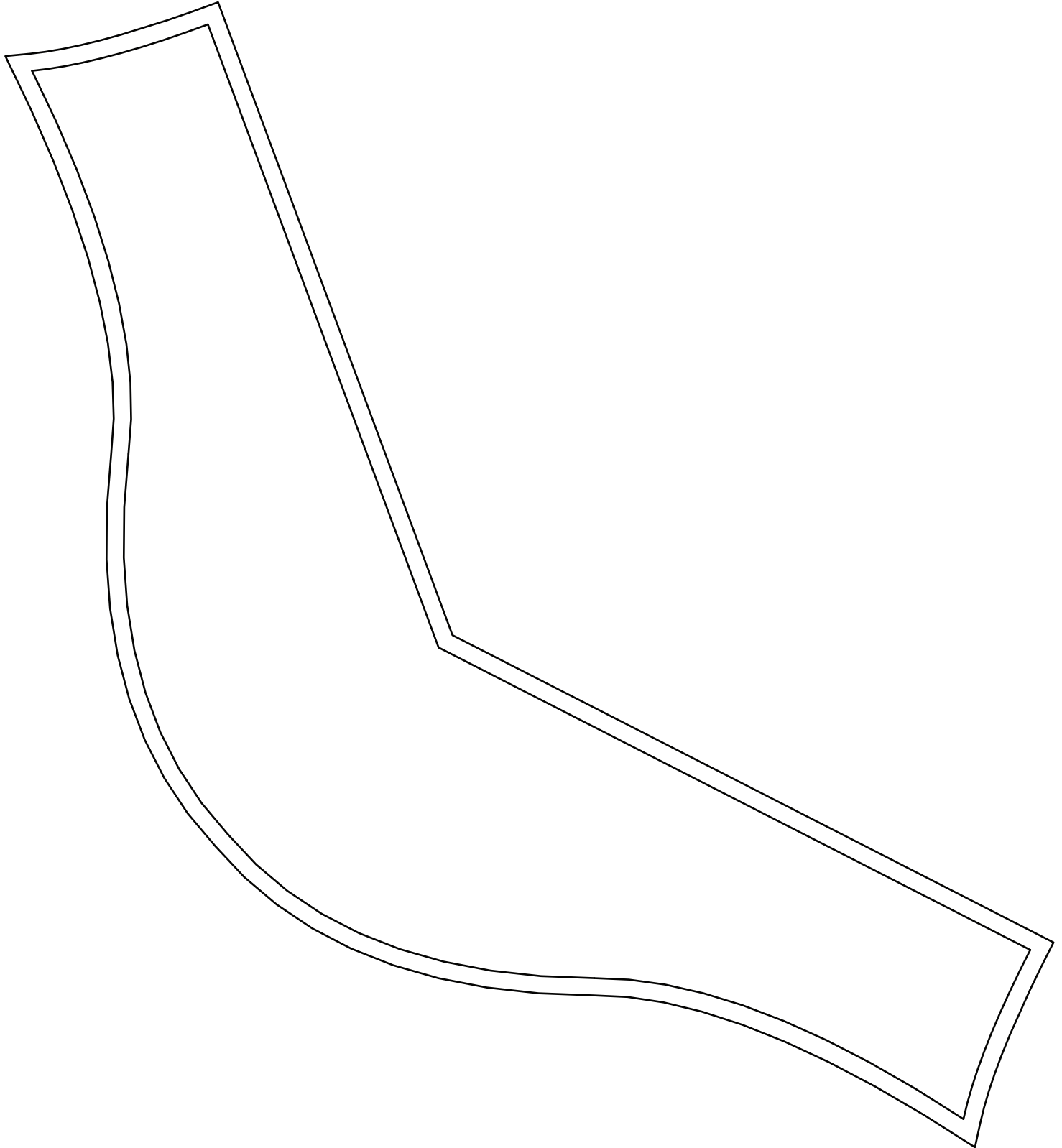



DIY CUT PATTERN

S/M FOR SIZE S/M. SCALE UP TO 2X CURRENT DOCUMENT SIZE

M/L FOR SIZE M/L. SCALE UP TO 2.17X CURRENT DOCUMENT SIZE

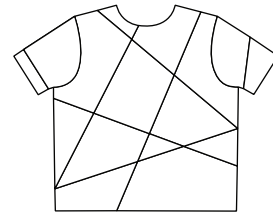

FRONT

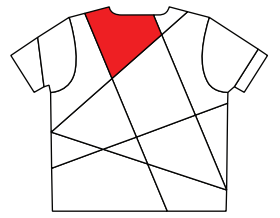

BACK

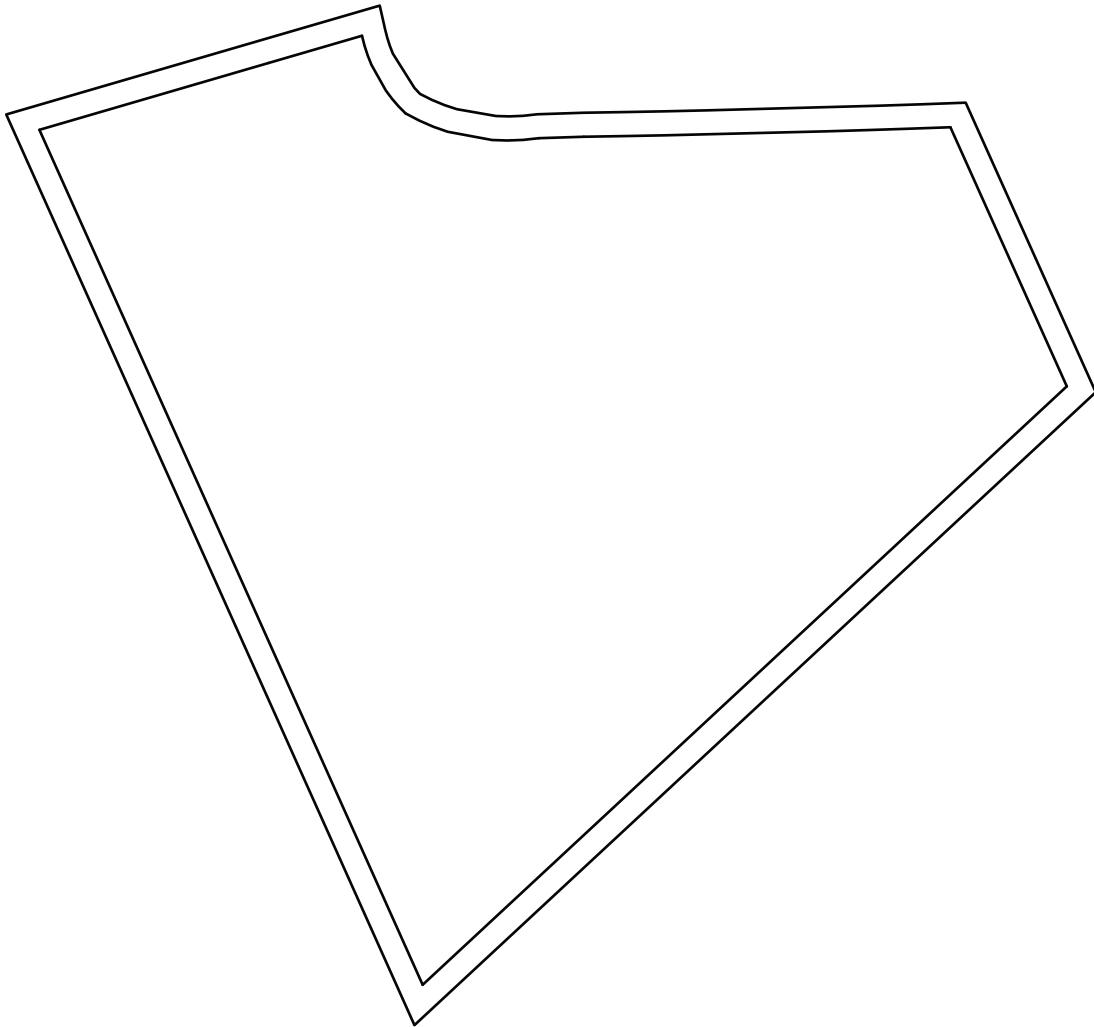



DIY CUT PATTERN

S/M FOR SIZE S/M. SCALE UP TO 2X CURRENT DOCUMENT SIZE

M/L FOR SIZE M/L. SCALE UP TO 2.17X CURRENT DOCUMENT SIZE

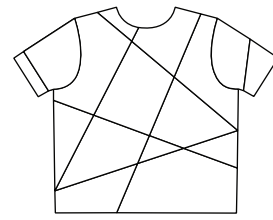

FRONT

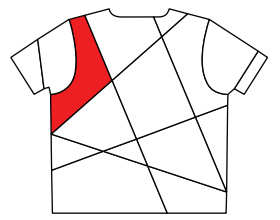

BACK

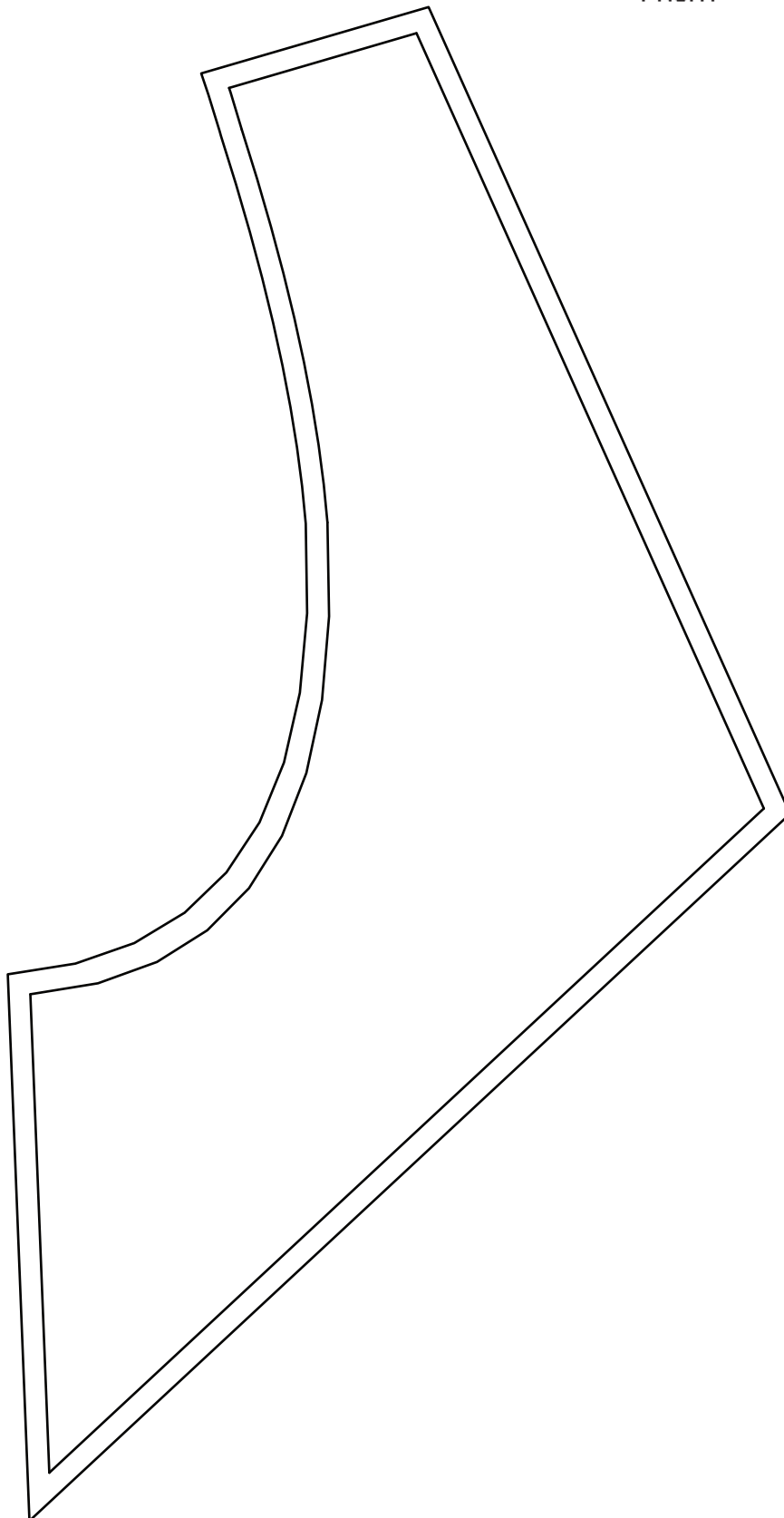



DIY CUT PATTERN

S/M FOR SIZE S/M. SCALE UP TO 2X CURRENT DOCUMENT SIZE

M/L FOR SIZE M/L. SCALE UP TO 2.17X CURRENT DOCUMENT SIZE

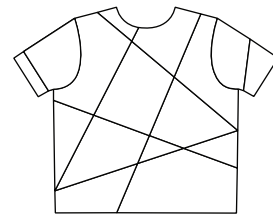

FRONT

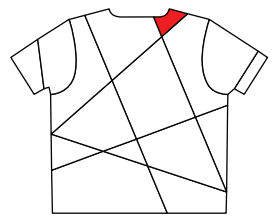

BACK

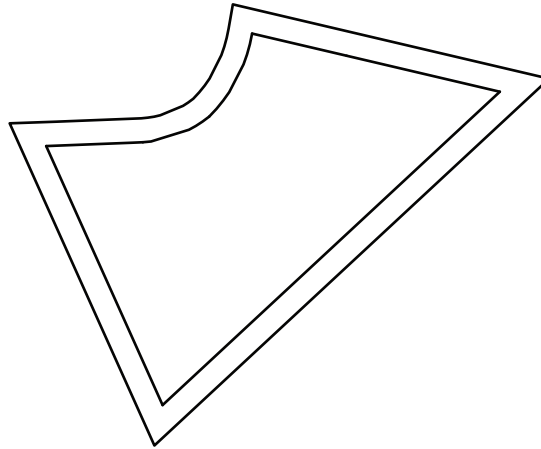



DIY CUT PATTERN

S/M FOR SIZE S/M. SCALE UP TO 2X CURRENT DOCUMENT SIZE

M/L FOR SIZE M/L. SCALE UP TO 2.17X CURRENT DOCUMENT SIZE

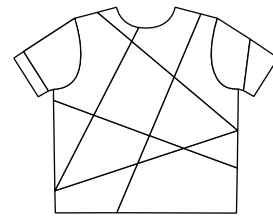

FRONT

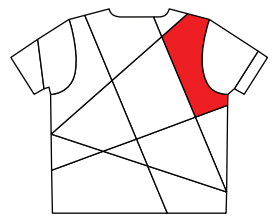

BACK

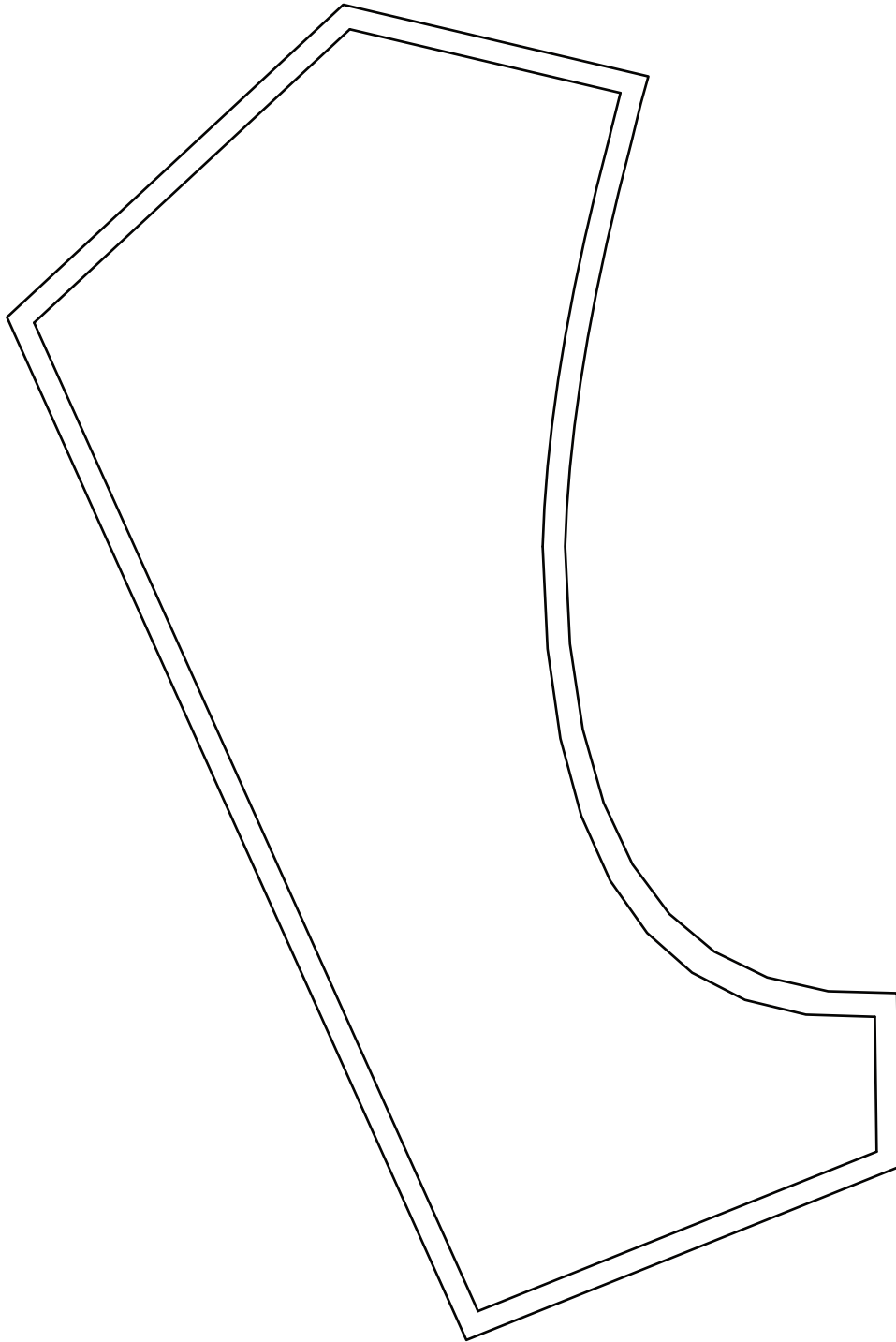



DIY CUT PATTERN

S/M FOR SIZE S/M. SCALE UP TO 2X CURRENT DOCUMENT SIZE

M/L FOR SIZE M/L. SCALE UP TO 2.17X CURRENT DOCUMENT SIZE

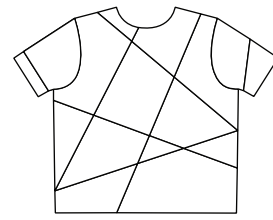

FRONT

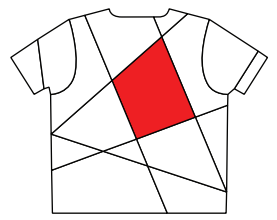

BACK

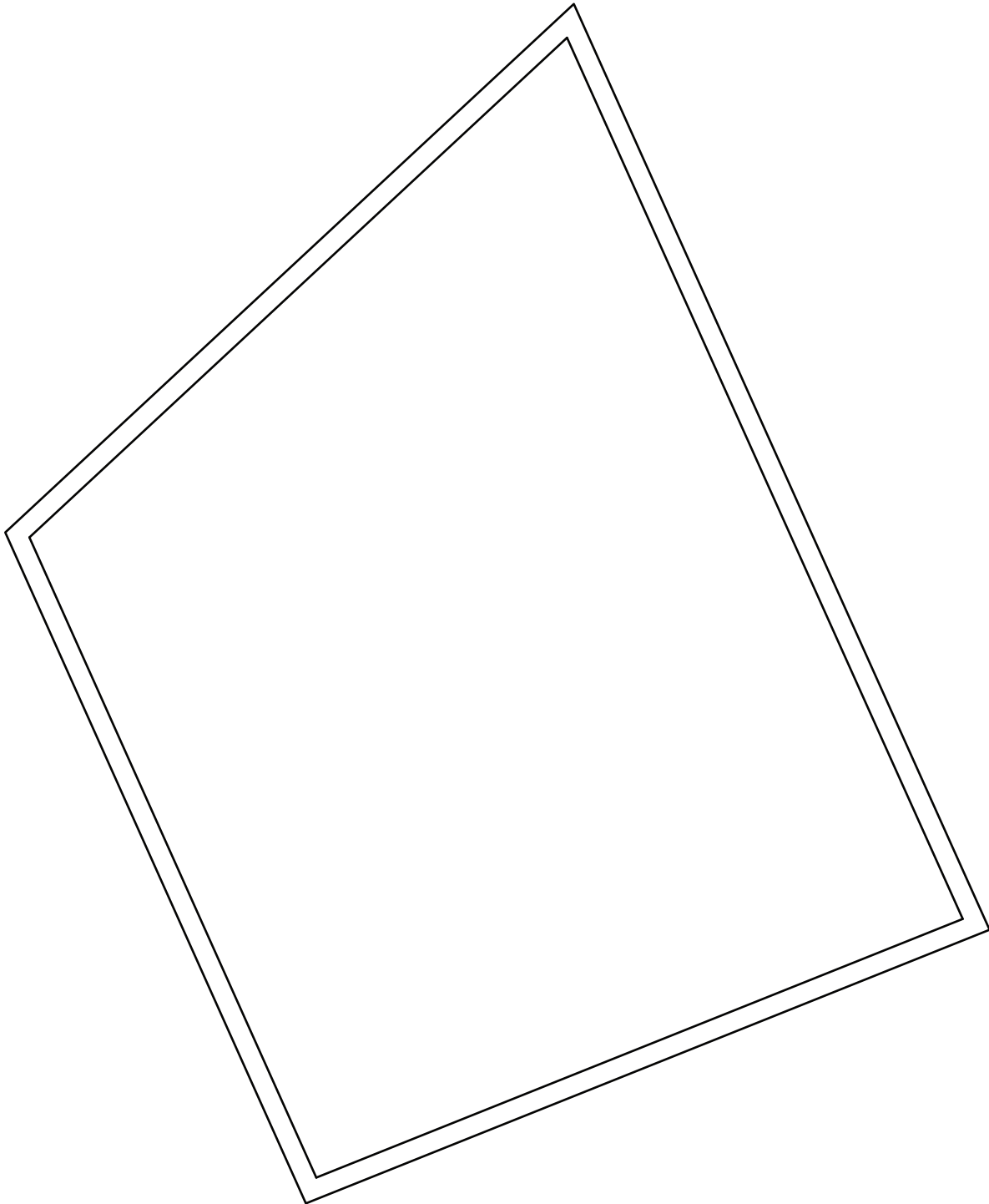



DIY CUT PATTERN

S/M FOR SIZE S/M. SCALE UP TO 2X CURRENT DOCUMENT SIZE

M/L FOR SIZE M/L. SCALE UP TO 2.17X CURRENT DOCUMENT SIZE

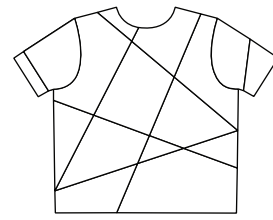

FRONT

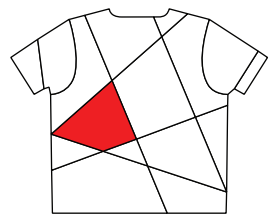

BACK

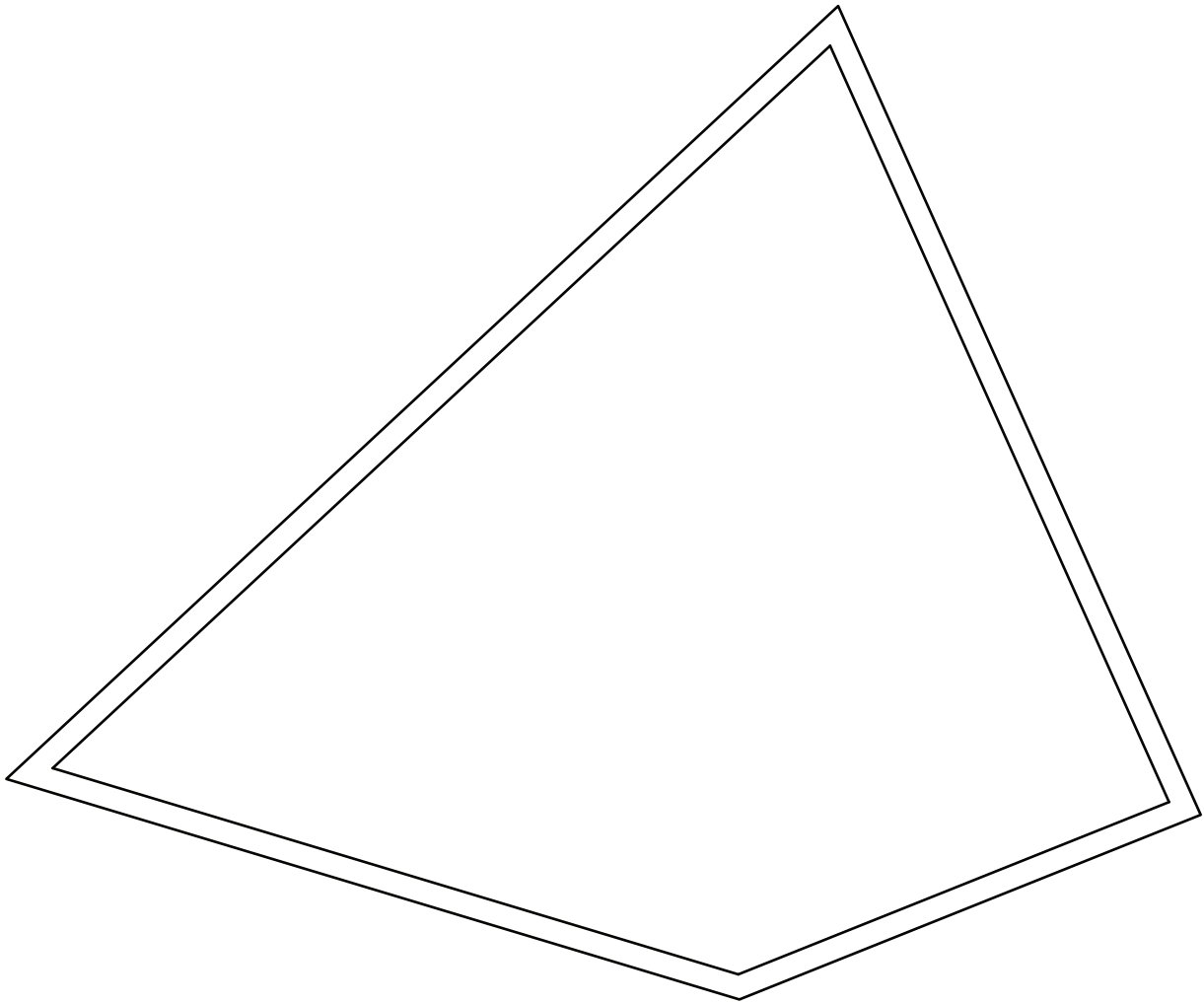



DIY CUT PATTERN

S/M FOR SIZE S/M. SCALE UP TO 2X CURRENT DOCUMENT SIZE

M/L FOR SIZE M/L. SCALE UP TO 2.17X CURRENT DOCUMENT SIZE

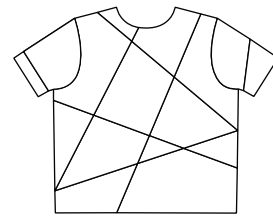

FRONT

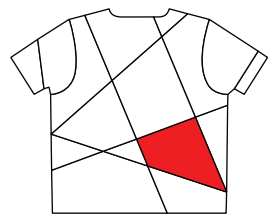

BACK

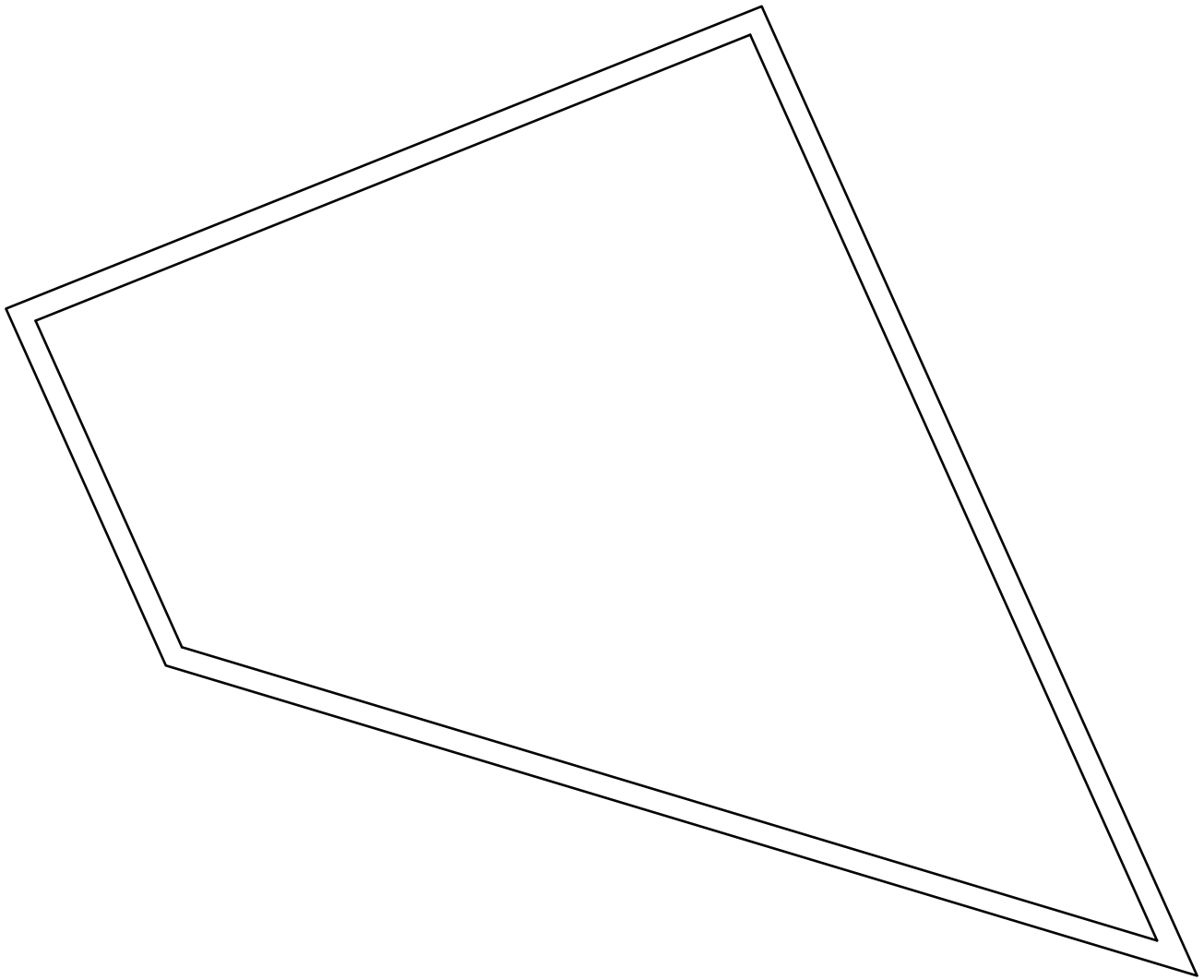



DIY CUT PATTERN

S/M FOR SIZE S/M. SCALE UP TO 2X CURRENT DOCUMENT SIZE

M/L FOR SIZE M/L. SCALE UP TO 2.17X CURRENT DOCUMENT SIZE

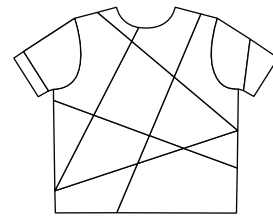

FRONT

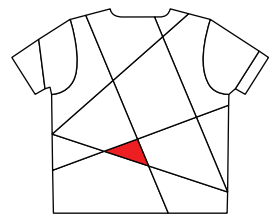

BACK

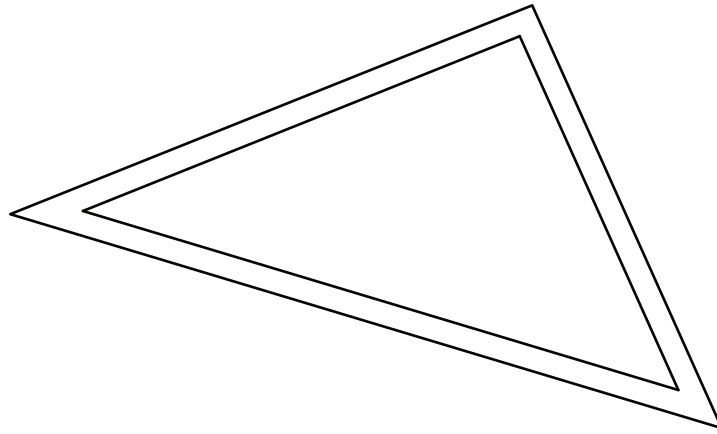



DIY CUT PATTERN

S/M FOR SIZE S/M. SCALE UP TO 2X CURRENT DOCUMENT SIZE

M/L FOR SIZE M/L. SCALE UP TO 2.17X CURRENT DOCUMENT SIZE

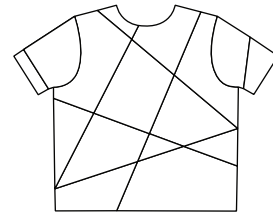

FRONT

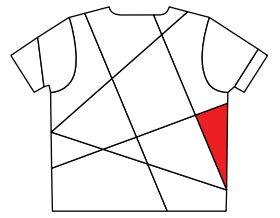

BACK

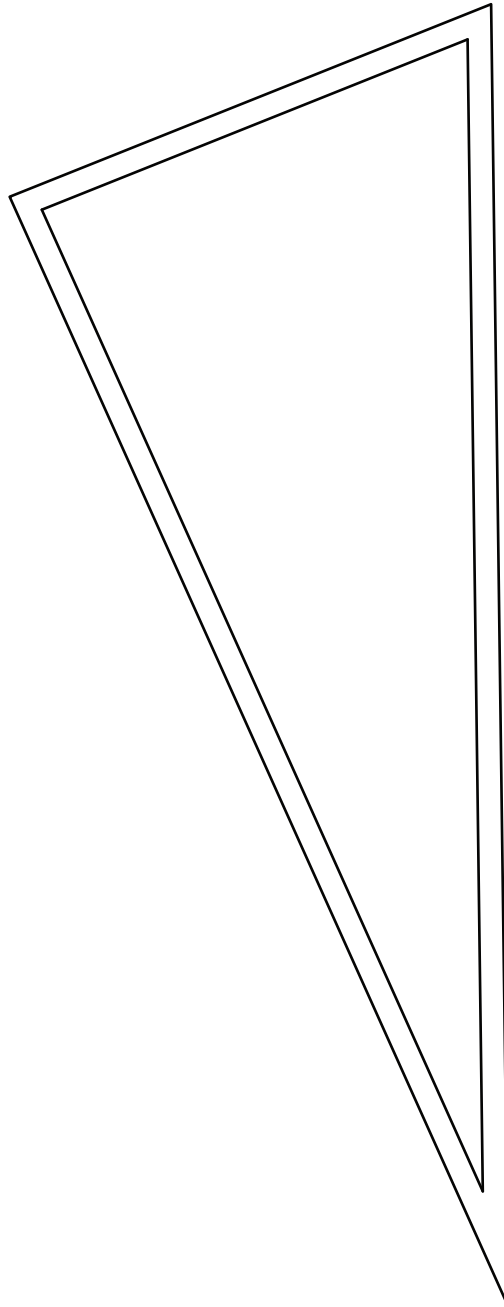



DIY CUT PATTERN

S/M FOR SIZE S/M. SCALE UP TO 2X CURRENT DOCUMENT SIZE

M/L FOR SIZE M/L. SCALE UP TO 2.17X CURRENT DOCUMENT SIZE

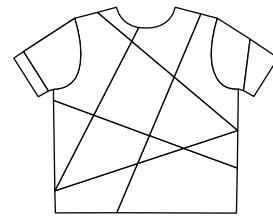

FRONT

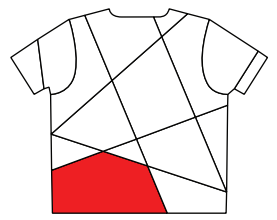

BACK

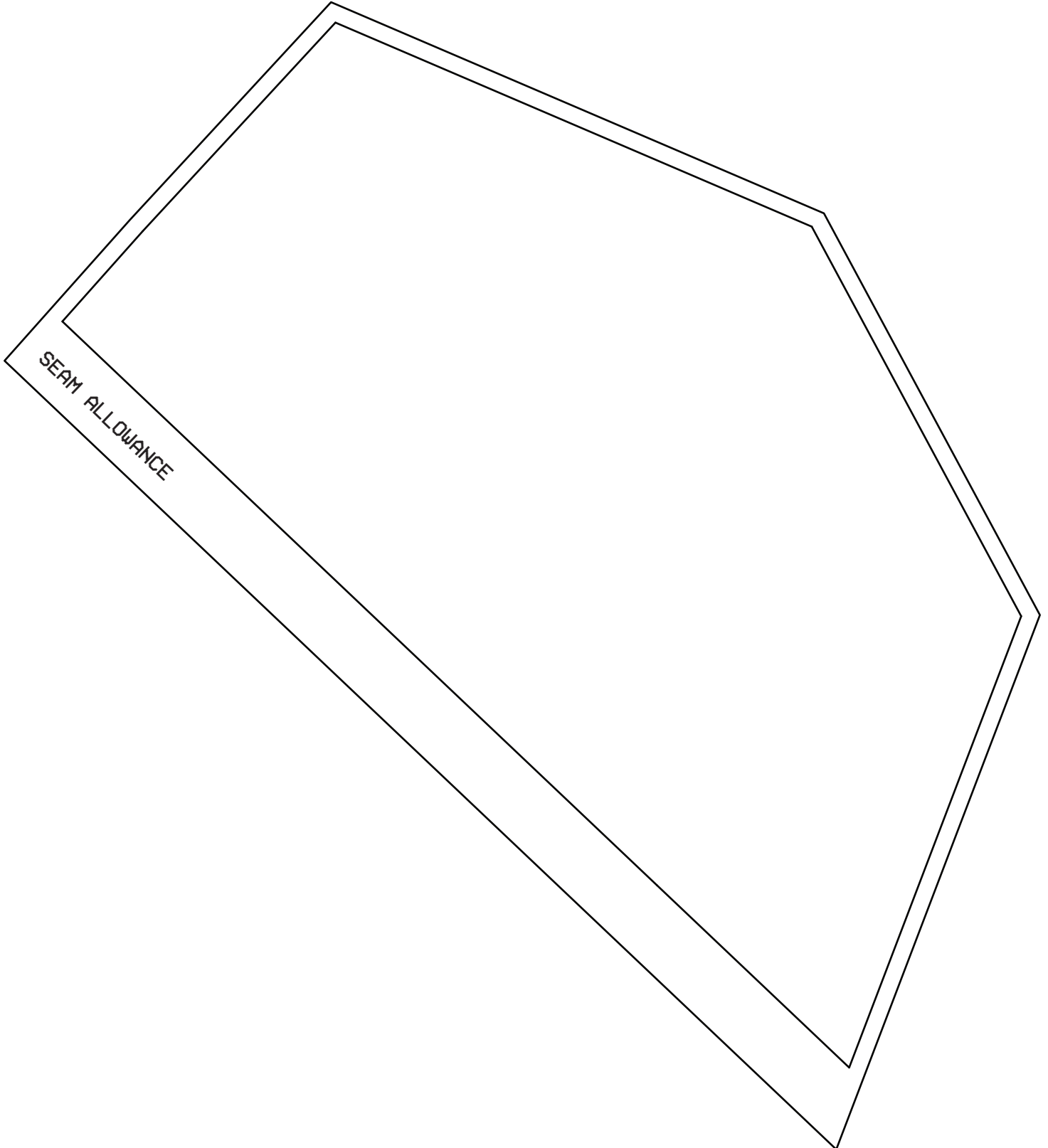



DIY CUT PATTERN

S/M FOR SIZE S/M. SCALE UP TO 2X CURRENT DOCUMENT SIZE

M/L FOR SIZE M/L. SCALE UP TO 2.17X CURRENT DOCUMENT SIZE

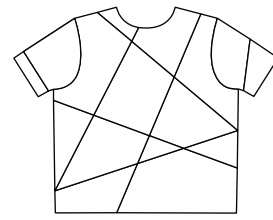

FRONT

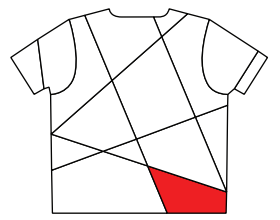

BACK

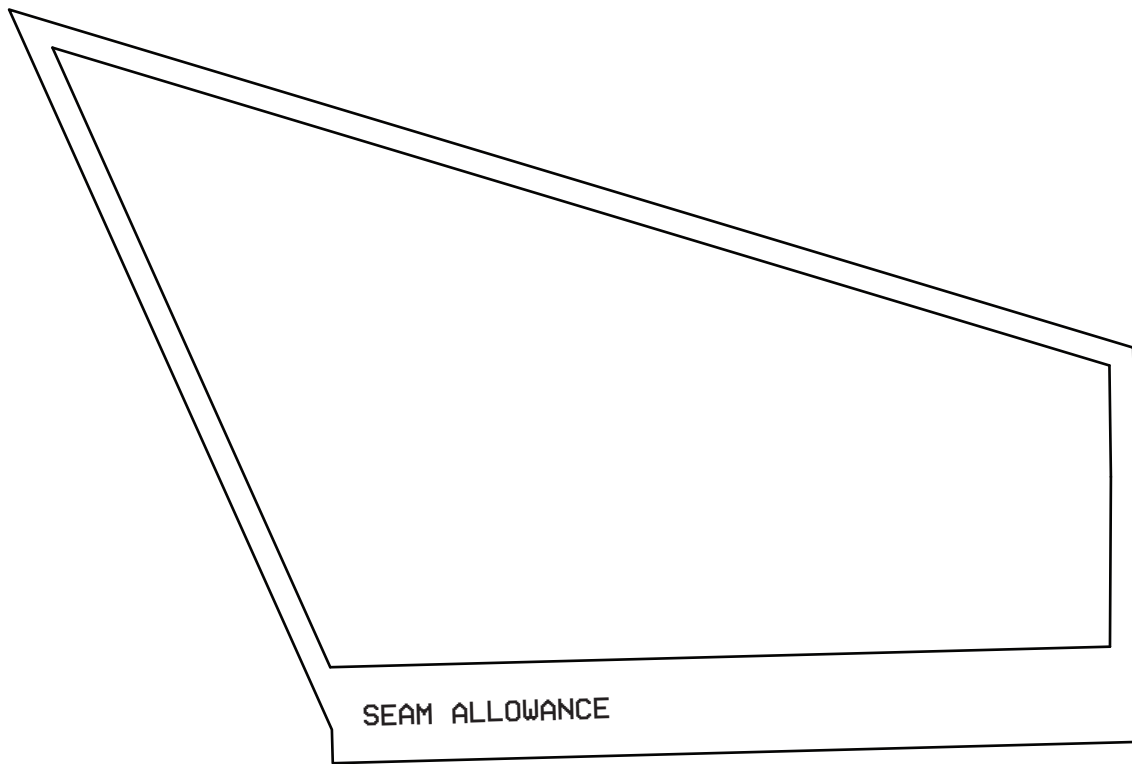



DIY CUT PATTERN

S/M FOR SIZE S/M. SCALE UP TO 2X CURRENT DOCUMENT SIZE

M/L FOR SIZE M/L. SCALE UP TO 2.17X CURRENT DOCUMENT SIZE

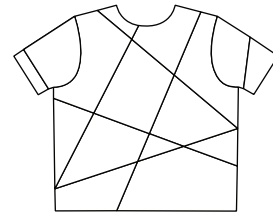

FRONT

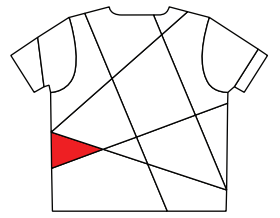

BACK

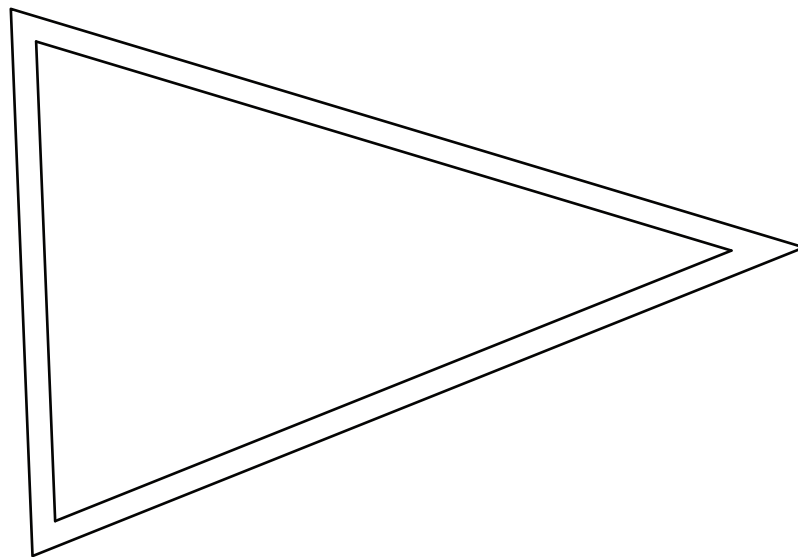



DIY CUT PATTERN

S/M FOR SIZE S/M. SCALE UP TO 2X CURRENT DOCUMENT SIZE

M/L FOR SIZE M/L. SCALE UP TO 2.17X CURRENT DOCUMENT SIZE

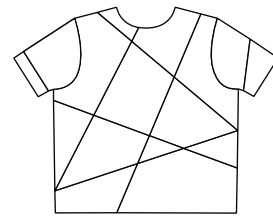

FRONT

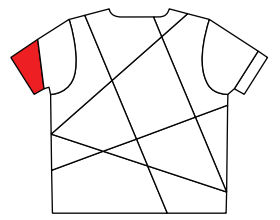

BACK

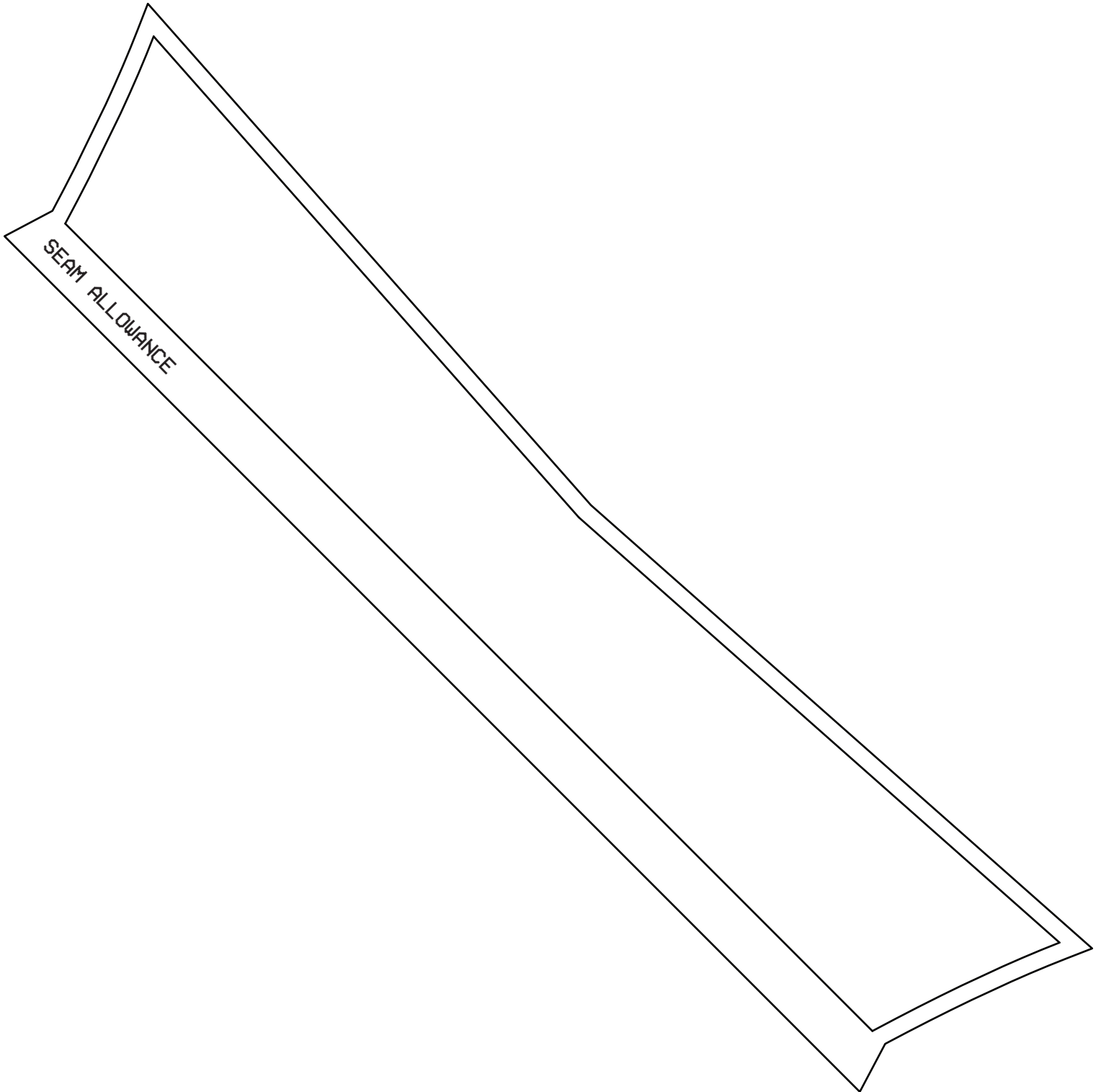



DIY CUT PATTERN

S/M FOR SIZE S/M. SCALE UP TO 2X CURRENT DOCUMENT SIZE

M/L FOR SIZE M/L. SCALE UP TO 2.17X CURRENT DOCUMENT SIZE

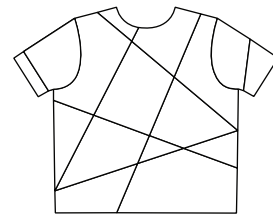

FRONT

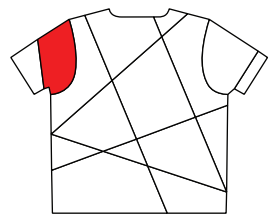

BACK

